

QUESTIONS FOR THOSE PREPARING FOR LSIT
Compiled from a variety of sources

1. A vara is:
 - a. a unit of area.
 - b. the equivalent of a section in the southwest U.S.
 - c. a unit of length.
 - d. a unit of angular measurement.
 - e. an optical rangefinder.

2. The science of dendrology is useful to the surveyor because:
 - a. Various formations of sand dunes provide study of classical topographic shapes.
 - b. When surveying in hot humid or tropical climates, prevention of disease is a concern.
 - c. Identification of rocks with crystalline structure is sometimes needed in surveying.
 - d. statistics on births, deaths, and other population data must sometimes be noted on maps.
 - e. tree identification is an important consideration in many retracement surveys.

3. Every parcel of land whose boundaries are surveyed by a licensed surveyor should be made conformable with:
 - a. the Lambert Conformal Conic Projection.
 - b. the terms of the contract negotiated with the owner.
 - c. the Manual of Instruction for the Survey of Public Lands.
 - d. record title boundaries of such land.
 - e. consent of the tax assessor.

4. A typical subdivision in a town or city is an example of:
 - a. eminent domain.
 - b. adverse possession.
 - c. simultaneous conveyancing.
 - d. sequence conveyancing.
 - e. riparian rights.

5. When is it proper to apply proportionate measurement to the location of property corners?
 - a. To distribute a few feet of gap found to exist between a subdivision boundary and the boundary of the original tract.
 - b. When relocating lost corners in a sequence conveyance.
 - c. When relocating lost corners in a platted subdivision.
 - d. All of the above.
 - e. None of the above.

6. In a deed description, the term "normal to" is used to describe:
 - a. one line as tangent to another.
 - b. a situation where witness corners have been set.
 - c. the median or middle portion.
 - d. a position adjacent or contiguous to another previously described position.
 - e. perpendicular lines.

7. A quit-claim deed is:
 - a. a special deed filed in Federal Court to cease operation of a mining claim.
 - b. a deed which relinquishes title and guarantees title to be with the grantor.
 - c. a deed which relinquishes whatever claim to title the grantor may possess.
 - d. a deed not recorded in the court house, but one that may legally transfer title.
 - e. a form of unwritten conveyance.

8. Which of the following is not an acceptable form of parol evidence?
 - a. Testimony relating to the former position of a monument when written evidence is not clear.
 - b. Testimony correcting statements in the deed.
 - c. Testimony as the general reputation of a monument.
 - d. Testimony of the general meanings of words and customs at the date of the deed.
 - e. Testimony to explain a latent ambiguity.

9. The description of Huffman's land ends with the phrase "together with an easement across Johnson's land for road purposes as shown...". With respect to Huffman's description, the easement is:
- informative
 - controlling
 - simultaneous
 - encumbering
 - augmenting
10. Metes and bounds descriptions are:
- The only kind used in written deeds.
 - Not used in modern deeds.
 - Fixed by adjoiners.
 - Fixed by adjoiners, monuments, distances, and directions.
 - Recommended for simultaneous conveyances.
11. A portion of a deed reads as follows:
- ". . . from an iron pipe at A proceed N 45° E a distance of 500.00 feet to an old truck axle at B; thence proceed N 30° W a distance of 700.00 feet to an iron pin at C".*
- The iron pins are found and verified as correct but the truck axle is found to be N 45° E 510 feet from point A. What action should the surveyor take?*
- Use all of the distance and bearing descriptors because they are controlling.
 - Use all of the distance and bearing descriptors because land surveyors seldom use truck axles for monuments
 - Establish the point B using "N 45° E a distance of 500.00 ft" since this retraces the steps of the original surveyor.
 - Intersect the two distances given because distances usually are controlling over bearings.
 - Use the location of the truck axle as found.
12. Possession lines may be used as field evidence to prove the physical location of record title if:
- Record title is based on an original survey and possession was established soon after the original survey was made.
 - Possession has existed for more than the statutory period.
 - There has been an unwritten agreement between the adjoining parties.
 - The adjoining parties have acquiesced in the possession line.
 - The adjoining parties are estopped from claiming to the true line when found.
13. The boundaries of the U.S. Public Lands, when approved and accepted by the proper U.S. Government agency, are generally unchangeable, except in which of the following cases?
- Junior rights are interfered with
 - Adjacent property owners file suit against the government
 - Mexican Land Grants are interfered with
 - When the statutory Period of compliance has elapsed
 - When a dependent resurvey shows the distance between section corners to actually be 81.00 chains.
14. Double proportionate measurement is used to replace lost corners of
- Township corners and interior section corners
 - Township corners and exterior section corners
 - Northwest sections of a township
 - Section corners on a standard parallel
 - Mineral surveys and meander corners.

-
15. The line of a U.S. Government tract of land is described as having a true bearing of S 00° 37' E. A land surveyor desires to retrace this line in the opposite direction, using a magnetic bearing. The declination in that area is 3° 20' east. What magnetic bearing should be used?
- N 2° 43' W
 - N 3° 57' W
 - N 3° 20' W
 - N 2° 43' E
 - N 3° 57' E
16. In the surveys for the public lands of the United States the closing corners along a township line:
- Are used to establish the true location of standard section corners within the township
 - Were established by recent surveys to control the ultimate subdivision of the township
 - Can be accepted as the true location of the standard Section corners
 - Are positioned on the ground by double proportionate method
 - Will control the direction of the North-South section line in an East-West direction
17. In trying to find an old original land corner you find that the surveyor, in chaining out the line, crossed a stream at 45.6 chains and set the corner at 51.25 chains total measure. From other lines in the area, you find a very constant chaining factor of 100.00 feet of your measure equals 99.75 feet of the original surveyor's. How far beyond the same point in the stream would you measure to find the original corner today? Assume the stream has not shifted.
- 5.66 feet
 - 66.00 feet
 - 371.97 feet
 - 372.90 feet
 - 373.84 feet
18. On an original survey made more than 100 years ago the surveyor marked and recorded a large pine tree as a witness to one of the survey corners. Less than 10 years thereafter, the pine was cut down in a logging operation. In order to verify this old survey corner it is desirable to find evidence of the location of this witness tree. The best way to accomplish this is to:
- prod the ground with a long iron rod until the location of the decayed tap route is found.
 - interview loggers that have worked in the area.
 - use a dip needle until the remains of the old stump hole are found.
 - view old aerial photographs with a stereoscope.
 - perform half-life soil tests for remains of pine needles.
19. In the U.S. Public Land Survey system, the normal number of sections in a township (except in very old surveys) is:
- 4
 - 6
 - 24
 - 36
 - 80
20. A survey corner which is regarded as lost is best defined as:
- A corner which may be perpetuated by setting a monument as the result of office and field research, aided by testimony of local old-time residents.
 - A corner which cannot be located without resorting to a survey based upon monuments related to the corner being sought.
 - A corner whose position has been retraced through the use of acceptable accessories to the original monument.
 - A corner which has been located by use of reference information contained in the field notes of the original survey.
 - A position verified only by its relation to natural topographic objects.

-
21. Section 18 of T21N, R6W, was subdivided for the first time about 20 years ago. You wish to retrace that survey. For the north line of the NW1/4 of the NW1/4 (also called Lot 1), what measurement should have been used if the official distance for the north line of Section 18, shown in government notes, is 78.39 chains?
- 10.00 chains
 - 18.39 chains
 - 19.20 chains
 - 19.60 chains
 - 38.39 chains
22. The center of a standard section of land is
- The point of intersection of two lines; one run for the NE section corner to the SW section corner, and the other from the NW Sec. corner to the SE Sec. corner.
 - A point located 40 chains south and 40 chains West of the NE section corner
 - A point located 40 chains north and 40 chains east of the SW section corner
 - The point of intersection of a line from the north ¼ corner to the south ¼ corner with a line running from the east ¼ corner to the west ¼ corner
 - A point identified by the intersection of the meridian line and the range line
23. Avulsion is:
- the slow and imperceptible accumulation of material by natural causes by a body of water.
 - the gradual recession of water resulting in uncovering of land which was once submerged.
 - an act by which a riparian owner may prohibit others from using his littoral rights.
 - the sudden and rapid removal of a considerable quantity of land by action of water.
 - a river process by which a thalweg is produced.
24. Concerning riparian boundaries, which of the following statements is generally held to be true?
- The U.S. Government Meander Line of a navigable stream is the boundary line.
 - Following erosion, property ownership lines are not affected.
 - Following an avulsion, property ownership lines are not affected.
 - Where the body of water is navigable, a littoral owner does not acquire title to land created by reliction.
 - Where the body of water is navigable, a littoral owner does not acquire title to land created by accretion.
25. Where, from natural causes, land forms by imperceptible degrees upon the bank of a river or stream, the process and end result are called:
- Accretion.
 - Littoral
 - Reliction
 - Erosion
 - Revsion
26. Riparian means:
- To revert or go back to the former owner.
 - To divide, share, or distribute proportionally.
 - Of or belonging to the bank of a river.
 - A unit of circular measure equal to $57^{\circ} 17' 44.8''$.
 - The right to use or cross over property of another.
27. A property parcel which borders on a small non-navigable stream will usually be bounded by
- mean low water
 - the thread of the stream
 - the mean high water line
 - the deepest part of the channel
 - the flood line
28. The value of the Products of 53.4×0.0023 , using the correct significant figure is:
- 0.12282
 - 0.1228
 - 0.123
 - D:0.12
 - 0.1

29. The sides of a triangular shaped parcel of land were determined to be 45.0 feet, 53.0 feet and 62.0 feet. What is the area of the parcel?
- 1395 sq. feet
 - 1643 sq. feet
 - 385 sq. feet
 - 1166 sq. feet
 - 1192 sq. feet
30. Given:
- $$10x + 5y = 235$$
- $$21x + 9y = 405$$
- Solve for Y
- 36
 - 6
 - 15
 - 45
 - 59
31. Two lines are defined by the following equations:
- $$2x + y - 6 = 0$$
- $$4x - 3y + 8 = 0$$
- The lines intersect at:
- $x = 0, y = 0$
 - $x = \frac{1}{2}, y = 5$
 - $x = 1, y = 4$
 - $x = 2, y = 2$
 - $x = 3, y = 3$
32. Assuming the earth is a sphere and its radius is 5,631 miles, the latitude of a point that is 2,700 miles north of the equator is most nearly:
- $21^{\circ}47'26''\text{N}$
 - $27^{\circ}28'22''\text{N}$
 - $21^{\circ}36',46''\text{N}$
 - $21^{\circ}22'03''\text{N}$
33. A theodolite is used to sight on a 1 inch diameter range pole at a distance of 172 ft. If the edge of the range pole is sighted instead of the center, the angular error introduced in the direction of the line is most nearly:
- 35"
 - 50"
 - 70"
 - 100"
34. One corner of a 60-ft x 120-ft lot, otherwise rectangular, is a curve with a radius of 20ft and a central angle of 90° . The area (ft²) of the lot is most nearly:
- 6,872
 - 6,886
 - 7,114
 - 7,200
35. An EDM measured a slope distance of 9876.54 m, and a zenith angle of $87^{\circ}34'55''$. What is the Horizontal Distance in U.S. Survey Feet?
- 32,119.98 feet
 - 32,205.67 feet
 - 32,368.52 feet
 - 32,368.58 feet
 - 32,374.43 feet
 - 32,374.49 feet

36. A traverse was run from Point A to Point E, and the coordinates of each point were computed with the following results:

Point	X Coordinate	Y Coordinate
A	100.00	100.00
B	250.55	232.66
C	388.26	95.98
D	466.15	2.15
E	609.50	-11.92

The distance and bearing, respectively, of a straight line from Point A to Point E are most nearly:

- a. 517.06 ft, S09°54'E
- b. 517.06 ft, S80° 06' E
- c. 521.65 ft, S 12° 23' E
- d. 521.65 ft, S 77° 37' E

37. You are set up on a building "A" with a theodolite (HI = 5.00 feet). You measure a zenith angle to the top of a Building "B" of $62^\circ 12' 50''$ and a zenith angle to the bottom of Building "B" of $144^\circ 32' 25''$. Building "B" is 845 feet tall. How far is building "A" from building "B"?

- a. 840.0 ft
- b. 746.9 ft
- c. 688.3 ft
- d. 557.5 ft
- e. 437.6 ft

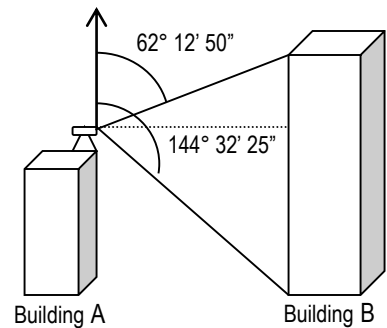

38. On the lot shown to the right, determine the buildable area which is delineated by the dashed line. (Note all dimensions are in feet).

- a. 1.40 acres
- b. 1.77 acres
- c. 1.80 acres
- d. 1.84 acres
- e. 2.29 acres

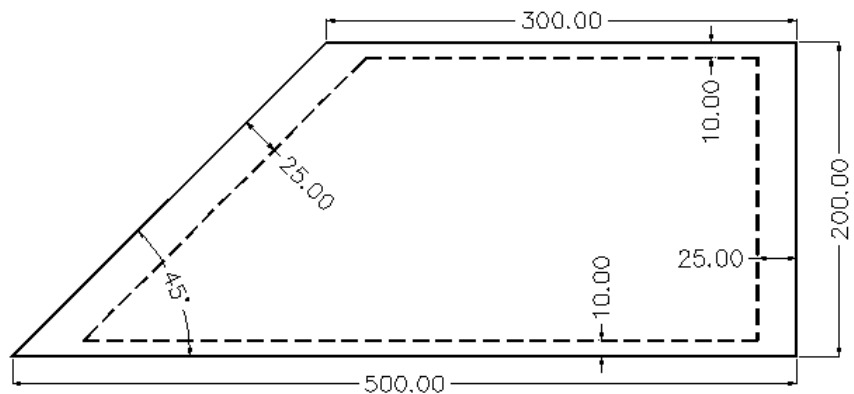

39. What is the clockwise (angle right) angle Set on Point "A", Backsighting Point "B" and turning to the northwest corner of the pad as shown at the right?
- 7° 22' 09"
 - 18° 26' 06"
 - 22° 37' 12"
 - 341° 33' 54"
 - 352° 37' 50"

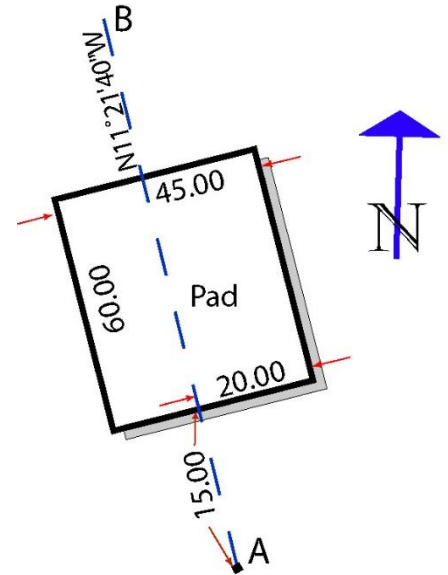

40. The distance was measured between two points, using the tape that is short 0.02' per 100 feet. The measurements were not measured along the line, but were measured as shown below. What is the true distance between the points?

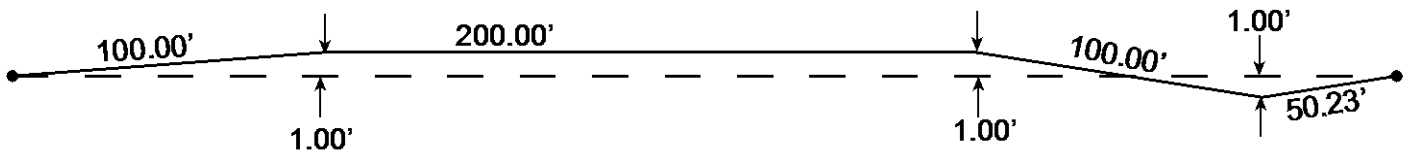

- 450.11
 - 450.13
 - 450.15
 - 450.16
 - 450.20
 - 450.23
41. What is the height of a power pole from where it goes into the Ground to the Cross Arm based on the following information? Set on Point "O". Elev of "O" = 234.56, HI = 5.24 Readings to prism at pole: Vertical Angle = 98°45' 20", Slope Distance = 378.94', HR = 5.00; Vertical angle to Cross Arm = 92° 50' 50"
- 258.43
 - 182.12
 - 177.12
 - 100.00
 - 81.31
 - 76.31
 - 44.05
42. What is the elevation of point "A" based on the following information? You are set up on Point "A", sighting Point B which has an elevation of = 734.78'. The HI at "A" = 5.25' and the rod at "B" = 4.25'. A zenith angle from A to B = 84° 15' 00" and the slope distance from A to B = 1845.67'
- 920.69
 - 919.69'
 - 918.69
 - 550.87
 - 549.87
 - 548.86

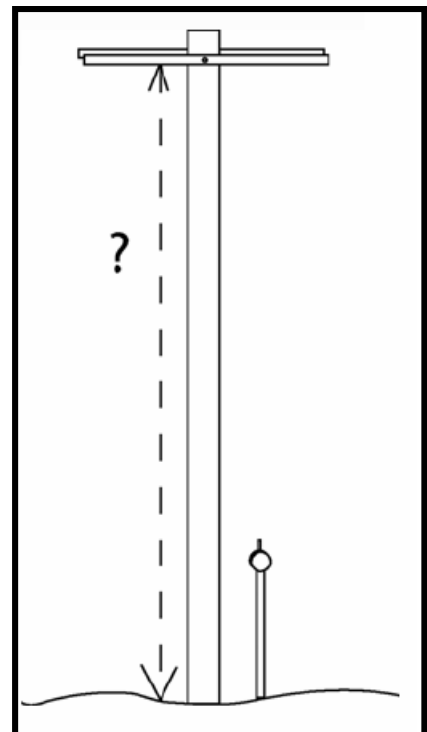

43. On a quad map (Scale 1:24000) the perpendicular distance between 1200' contour and the 1400' contour measures 1.25 inches. What is the slope between those two points?
- 0.62%
 - 0.66%
 - 0.80%
 - 6.66%
 - 8.00%

44. The table to the right shows areas of cut for the contour slice volume calculations. What is the volume of Cut?
- 135 Cu. yds.
 - 270 Cu. yds.
 - 405 Cu. yds.
 - 810 Cu. yds.
 - 3645 Cu. yds.

Contour (ft.)	Area (Sq. ft.)
342	1850
344	2200
346	1040

45. In a traverse, the distances are measured with a precision of 1:12000. What range of uncertainty in angle measurement would most nearly correspond with the precision of the distance measurements?
- 17 seconds
 - 36 seconds
 - 48 seconds
 - 60 seconds
 - 2 minutes

46. What is the elevation of point "A" based on the following information?

Set up on Point "A" Elevation of "B" = 1734.78'
Vertical angle from A to B = 82°15'00" (Zenith)

HI at "A" = 5.25' Rod at "B" = 4.25'
Slope Distance from A to B = 845.67'

- 897.83
- 1619.74
- 1620.74
- 1848.82
- 1849.82

47. You are staking a 70.00' x 50.00' pad as shown above. You are set on "E" and backsighting "F", what is the clockwise angle to the SE corner of the pad?

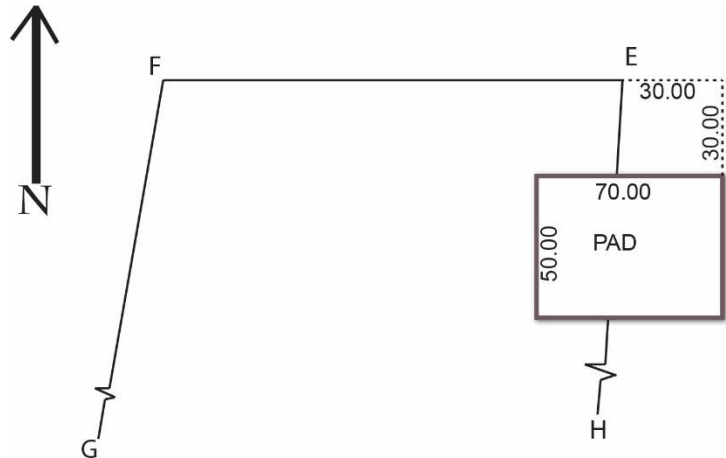

- 45° 00' 00"
- 225° 00' 00"
- 249° 26' 40"
- 290° 33' 20"
- 315° 00' 00"

48. If the Azimuth from "E" to "F" is 268° 00' 00", what is the Azimuth from "E" to the NE corner of the pad?

- 313° 00' 00"
- 133° 00' 00"
- 157° 26' 40"
- 198° 33' 20"
- 223° 00' 00"

49. What is the distance from "E" to the SW corner of the pad?

- 79.56 feet
- 80.00 feet
- 85.44 feet
- 86.02 feet
- 89.44 feet

50. What is the Station and elevation of the point of intersection for a tangent that has a grade of -3.50% and an elevation of 352.56 at station 10+00; with a tangent that has a grade of + 4.25% and an elevation of 335.00 at station 20+00?
- 15+00 Elev.= 335.06
 - 15+00 Elev.= 313.75
 - 17+75 Elev.= 325.43
 - 18+00 Elev.= 324.56
 - 18+25 Elev. = 327.56

51. What is the Average horizontal angle from A to C based on the table below?

- 13° 59' 30"
- 180° 00' 05"
- 193° 59' 30"
- 193° 59' 55"
- 194° 00' 00"

STATION		HORIZONTAL ANGLE		ZENITH ANGLE	
SETUP	Sight	First Reading	Second Reading	First Reading	Second Reading
	A	0° 00' 00"	179° 59' 50"	87° 45' 25"	272° 14' 25"
B					
	C	194°00'05"	13° 59' 45"	89° 55' 05"	270° 04' 55"

52. What is the average vertical angle from B to C on the table above?

- 2° 14' 30"
- 87° 45' 30"
- 88° 50' 15"
- 89° 55' 05"
- 179° 59' 55"

53. A surveyor tapes a distance of 1,296.33 feet with a 100-foot tape. If the standard error of measuring one tape length using his technique is +/- 0.020 feet, the standard error of the measured distance is:

- +/- 0.02
- +/- 0.05
- +/- 0.07
- +/- 0.13
- +/- 0.26

Point	Northing	Easting
A	1089.981	935.049
B	1000.000	1000.000
C	1078.754	1068.139
D	1500.000	1500.000
E	1030.252	1030.252

The following three questions are based on the table right.

54. What is the distance from "A" to "C"?

- 12.01'
- 78.75'
- 104.14'
- 110.97'
- 133.56'

55. What is the Direction from "A" to "C"?

- 175° 10' 41"
- 274° 49' 19"
- S 85° 10' 42" E
- S 11° 51' 16" W
- N 11° 51' 16" E

56. What are the coordinates of the point of intersection of a line that passes through Point B with an azimuth of 11° 30' 00" and a line that passes through Point D with an azimuth of 300° 30' 00"?

- N 790.51 E 1355.65
- N 1000.00 E 1500.00
- N 1144.36 E 1709.49
- N 1355.65 E 790.51
- N 1709.49 E 1144.36

57. In 1886, the magnetic bearing of a line was found to be N 87° 55' W when the declination was 4°37' W. If today, the declination is 0° 12' E, what would the magnetic azimuth (from north) of the same line be?
- 92° 20'
 - 267° 16'
 - 267° 40'
 - 276° 30'
 - 276° 54'

58. What is the Azimuth from "D" to "T" based on the following information and sketch?
Azimuth "C" to "D" = 251° 23' 50"
Interior Angle at "C" = 82° 15' 35"
Interior Angle at "T" = 15° 44' 25"

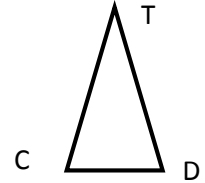

- 153° 23' 50"
 - 169° 23' 50"
 - 235° 39' 25"
 - 333° 23' 50"
 - 333° 39' 25"
59. You have determined the horizontal Dist. between your set up point "C" to a remote point "T" of being 5028.64 feet. You measured the Zenith angle to the remote points of 82° 35' 45". If Elevation of Point "C" is 100.00 your HI is 5.00 and HR 0.00, what is the elevation of Remote Point "T"?
- 653.48
 - 758.48
 - 648.03
 - 753.03
 - Not enough information to determine
60. The distance on a vertical aerial photograph between two east-west hedge lines is measured and found to be 7.96 inches. The hedge lines are approximately the north and south section lines of Section 16 which is regular. The terrain is approximately level. What is the approximate photo scale in the area of the two hedges?
- 1" = 663'
 - 1 : 663
 - 1 : 24000
 - 1" = 7960'
 - 1" = 1320'
61. An EDM distance of one mile is measured at an elevation of one mile. The earth's radius, R, is assumed to be 20,906,000 feet. What is the sea level distance in feet?
- 5270.02
 - 5278.67
 - 5280.00
 - 5281.33
 - 5291.99
62. In regards to Geographic Coordinates in California
- Latitudes increase to the east
 - Longitudes increase to the east
 - Departures increase to the east
 - Latitudes increase to the south
 - Longitudes increase to the west

Horizontal Curve data

$$STA_{PI} = 86+47.30 \quad R = 750.00 \quad \Delta = 24^\circ 30' 00''$$

63. Based on the information above, what is the Station of the BC?

- a. 83+05.51
- b. 83+26.60
- c. 83+29.03
- d. 84+84.46
- e. 88+10.14

64. What is the straight line distance from the BC to the EC?

- a. 311.02'
- b. 318.27'
- c. 320.70'
- d. 325.68'
- e. 750.00'

65. What is the Station of the EC?

- a. 86+26.21
- b. 86+47.30
- c. 86+49.74
- d. 88+05.16
- e. 91+30.85

66. What is the deflection angle to 87+00, set on the BC, back sight the PI?

- a. $4^\circ 12' 25''$
- b. $8^\circ 13' 59''$
- c. $14^\circ 10' 12''$
- d. $14^\circ 15' 47''$
- e. $15^\circ 04' 07''$

67. What is the Chord Distance from the BC to Station 87+00?

- a. 110.04'
- b. 214.80'
- c. 367.20'
- d. 369.56'
- e. 389.96'

68. What is the deflection angle, to 87+00 set on 85+00, backsight BC?

- a. $4^\circ 12' 25''$
- b. $8^\circ 13' 59''$
- c. $14^\circ 10' 12''$
- d. $14^\circ 15' 47''$
- e. $15^\circ 04' 07''$

69. Looking at the sketch, if the bearing from A to B is $N72^\circ 19' 40'' E$, the radius of the horizontal curve is 1850.00 feet and the arc length is 807.51 feet, what is the bearing from B to C?

- a. $S 82^\circ 39' 47'' E$
- b. $N 82^\circ 39' 47'' E$
- c. $N 47^\circ 19' 07'' E$
- d. $S 47^\circ 19' 07'' E$
- e. $N 92^\circ 20' 13'' E$

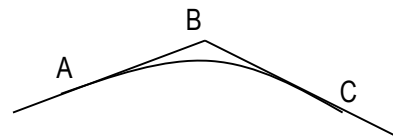

Vertical Curve Information : $VPI_{STA} = 15+00$ $VPI_{ELEV} = 320.50$ $L = 800.00$

$g_1 = -4.00\%$ $g_2 = +2.50\%$

70. Based on the information above what is the elevation and station of the BVC?
- a. 304.50' 7+00.00
 - b. 304.50' 11+00.00
 - c. 310.50' 11+00.00
 - d. 336.50' 11+00.00
 - e. 336.50 7+00.00
71. What is the elevation on the curve at station 15+00.00?
- a. 314.00
 - b. 320.50
 - c. 325.63
 - d. 327.00
 - e. 328.98
72. What is the station of the low point on the curve?
- a. 4+92.31
 - b. 15+00.00
 - c. 15+92.30
 - d. 16+73.89
 - e. 19+92.31
73. What is the elevation of the low point on the curve?
- a. 320.50
 - b. 321.00
 - c. 323.64
 - d. 326.65
 - e. 330.50
74. What is the elevation on the curve at station 19+00?
- a. 320.50
 - b. 321.00
 - c. 323.64
 - d. 326.65
 - e. 330.50
75. A road cross section (1/2 section) from the centerline is a -2% slope at 10 feet, a 6" curb, then a 5 foot wide sidewalk with a +1% slope and a 2 foot shoulder with a -5% slope, then side slopes of 4:1. The centerline elevation at station 12+35 is 780.56. If the ground at station 12+35 is level and at an elevation of 772.8, what is the distance from the centerline to the catch point?
- a. 31 feet
 - b. 32 feet
 - c. 47 feet
 - d. 48 feet
 - e. 49 feet
76. What is the cross-sectional area of fill at station 12+35 as described in the question above (Assume fill to road and sidewalk surface)?
- a. 133 sq ft
 - b. 261 sq ft
 - c. 266 sq ft
 - d. 522 sq ft
 - e. 784 sq ft

77. The distance on a vertical aerial photograph between two east-west hedge lines is measured and found to be 7.96 inches. The hedge lines are approximately the north and south section lines of Section 16 which is regular. The terrain is approximately level. What is the approximate photo scale in the area of the two hedges?
- 1" = 663'
 - 1 : 663
 - 1 : 24000
 - 1" = 7960'
 - 1" = 1320'
78. A map at a scale of 1:24,000, with contour interval of 10 feet, covers uniformly sloping terrain. The average spacing between the contours is found to be 0.05 inches. What is the average slope of the ground, in percent?
- 20
 - 10
 - 8
 - 5
 - 4
79. An aircraft carrying an aerial camera of focal length 6 inches flies over an area with average elevation of 3,000 feet above mean sea level (M.S.L.). What should be the height of the aircraft in feet above M.S.L. to obtain photography with an average scale of 1:30,000?
- 12,000
 - 15,000
 - 18,000
 - 21,000
 - 30,000
80. A field at an elevation of 2500 feet AMSL appears on a vertical photo taken at an altitude of 12,000 feet AMSL with a camera that has an 8.250 inch focal length. An electronic planimeter takes 5 readings on the field of 6.175, 6.185, 6.200, 6.170 and 6.160, (inches²). What is the area on the ground of the field, in acres?
- 592 sq ft
 - 56900 sq ft
 - 188 acres
 - 300 acres
 - 365 acres
81. A project that is 8000 feet by 4000 feet, is to be mapped at a 1 foot contour interval, using a camera with a 6 in focal length and standard 9" x 9" negatives. It will be plotted on a plotter with a C-factor of 2000. Assuming standard 60% forward overlap and 30% side overlap, how many flight lines and photos will be required? (assume the standard neat model size)
- One Flight line 4 photos
 - Two Flight lines 4 photos
 - Two Flight lines 8 photos
 - Two Flight lines 14 photos
 - Two flight lines 16 photos
82. A projection is
- A 3-D model of the world
 - A 2-D model of the world
 - The irregular shape of the world
 - The irregular shape at sea level
 - A surface model of the world
83. A geoid is
- A 3-D model of the world
 - A 2-D model of the world
 - The irregular shape of the world
 - The irregular shape at sea level
 - A surface model of the world

84. Rectification is
- Assigning a coordinate system to raster data
 - The process of converting an image to a specific coordinate system
 - Converting a datum to a projection
 - A linear transformation
 - A rather painful operation
85. An area with a mean terrain of 1000 feet AMSL, mapped to 2 foot contours and it is being plotted on a stereo plotter with a "C" value of 2000, What should the flying height be?
- 2000' ASML
 - 3000' ASML
 - 4000' ASML
 - 5000' ASML
 - 6000' ASML
86. If the neat model covers 40% forward and 70% side of a photo; What is the size of the neat model on a standard aerial photo?
- 0.36ft x 0.63ft
 - 3.6 in x 6.3 in
 - 0.40ft x 0.70ft
 - 4.0 in x 7.0 in
 - 235mm x 316mm
87. What is the size of the neat model on the ground, for the above question, if the photo scale is 1:3600?
- 1080ft x 1890ft
 - 1200ft x 2100ft
 - 1440ft x 2520ft
 - 2100ft x 2100ft
 - 12,960ft x 22,680ft
88. If an Aerial Panel is to be 0.02" long on the photograph, and the scale of the photos is going to be 1:3600, how long should the panels be on the ground?
- 3 feet
 - 6 feet
 - 12 feet
 - 60 feet
 - 72 feet
89. A histogram is a plot of
- Time over energy
 - Bands in one value to bands in another
 - Digital Count Values to occurrences
 - Classes to Pixels
 - DC values to LUT
90. An area of a field is measured to be 4.245 ln² on a photograph. The photo was taken at an elevation of 12,000' MSL with a camera that has a focal length of 6.015 inches. If the field is at an elevation of 3,500' MSL, what is the area of the field in acres?
- 0.137 acres
 - 0.194 acres
 - 195 acres
 - 387 acres
 - 2335 acres
91. Which of the following is NOT a common type of business ownership?
- Sole Proprietorship
 - Limited Proprietorship
 - Corporation
 - Partnership

92. LIDAR data returns the following information (Select all that apply):
- i. Elevations
 - ii. Distance from object
 - iii. Surface model
 - iv. Brightness
 - v. Intensity
- b. i,ii,& iv
 - c. i & iv
 - d. i & v.
 - e. iii & v
 - f. all of the above
93. While reviewing a record of survey performed by another surveyor in your area you observe the comment "Corner obliterate, recovered by collateral evidence". This statement means:
- a. All landowners affected by the corner location paid a fee to have it reestablished
 - b. The corer was reestablished by evidence other that the monument or its accessories
 - c. The corner was replaced by taking oaths by the surveyor's assistant
 - d. Evidence to its location was gathered in a court of law.
94. What is the datum used for the GPS Navigation message
- a. NAD83 (CORS96)
 - b. NAD27
 - c. GRS80
 - d. WGS84 (G1150)
95. Which one of the following is not considered a cause for positioning error with GPS
- a. Time difference measurement
 - b. Ephemeris Information
 - c. Atmosphere
 - d. Multipath
 - e. All of the above cause errors.
96. What is the advantage available using a dual frequency GPS receiver that is not available using a single frequency GPS receiver?
- a. A single frequency GPS receiver cannot collect enough data to perform single, double or triple difference solutions
 - b. A dual frequency receiver affords an opportunity to tract the P code but a single frequency receiver does not.
 - c. A dual frequency receiver has access to the navigation code, a single frequency does not
 - d. Over long baselines, a dual frequency receiver has the facility of modeling and virtually removing the ionospheric bias, whereas a single frequency receiver cannot.
97. Which of the following satellite identifiers is most widely used?
- a. Interrange operation Number
 - b. NASA catalog number
 - c. PRN number
 - d. NAVSTAR number
98. The line of a U.S. Government tract of land is described as having a true bearing of S 00° 37' E. A land surveyor desires to retrace this line in the opposite direction, using a magnetic bearing. The declination in that area is 3° 20' east. What magnetic bearing should be used?
- a. N 2° 43' W
 - b. N 3° 57' W
 - c. N 3° 20' W
 - d. N 2° 43' E
 - e. N 3° 57' E

99. The sides of a triangular shaped parcel of land were determined to be 45.0 ft., 53.0 ft., and 62 ft. What is the area of the parcel?
- 1395 sq ft
 - 1643 sq ft
 - 385 sq ft
 - 1166 sq ft
 - 1192 sq ft
100. Every parcel of land whose boundaries are surveyed by a licensed surveyor should be made conformable with:
- The Lambert Conformal Conic Projection.
 - The terms of the contract negotiated with the owner.
 - The Manual of Instruction for the Survey of Public Lands.
 - Record title boundaries of such land.
 - Consent of the tax assessor.
101. A map at a scale of 1:24,000, with contour interval of 10 feet, covers uniformly sloping terrain. The average spacing between the contours is found to be 0.05 inches. What is the average slope of the ground, in percent?
- 20
 - 10
 - 8
 - 5
 - 4
102. The description of Huffman's land ends with the phrase "together with an easement across Johnson's land for road purposes as shown...". With respect to Huffman's description, the easement is:
- informative
 - controlling
 - simultaneous
 - encumbering
 - augmenting
103. A survey corner which is regarded as lost is best defined as:
- a corner which may be perpetuated by setting a monument as the result of office and field research, aided by testimony of local old-time residents.
 - a corner which cannot be located without resorting to a survey based upon monuments related to the corner being sought.
 - a corner whose position has been retraced through the use of acceptable accessories to the original monument.
 - a corner which has been located by use of reference information contained in the field notes of the original survey.
 - a position verified only by its relation to natural topographic objects.
104. Which of the following errors are not reduced by using DGPS or RTK methods?
- Atmospheric errors
 - Satellite clock bias
 - Ephemeris bias
 - Multipath
105. When discussing elevations using GPS, what best describes the height of a point above the geoid?
- Ellipsoid height
 - Orthometric height
 - Geoid Separation
 - Differential level
 - Z
106. What is the meaning of Latency as applied to DGPS and RTK
- The baud-rate of a radio modem in real-time GPS
 - The time taken for a system to compute corrections and transmit them to users in real time GPS
 - The frequency of the RTCM SC104 correction signale in real time GPS
 - The range rate broadcast with the corrections from the base station.

107. Avulsion is:
- the slow and imperceptible accumulation of material by natural causes by a body of water.
 - the gradual recession of water resulting in uncovering of land which was once submerged.
 - an act by which a riparian owner may prohibit others from using his littoral rights.
 - the sudden and rapid removal of a considerable quantity of land by action of water.
 - a river process by which a thalweg is produced.
108. A surveyor finds a metal disk set in the ground and stamped U.S.C. & G.S. The agency to contact for information concerning this marker would be:
- U.S. Geological Survey
 - National Geodetic Survey
 - Bureau of Land Management
 - U.S. Corps of Engineers
 - U.S. Cartographic & Geodetic Service
109. A typical subdivision in a town or city is an example of:
- eminent domain.
 - adverse possession.
 - simultaneous conveyancing.
 - sequence conveyancing.
 - riparian rights.
110. In keeping notes for transit work, the reading after the first repetition is $125^{\circ} 16' 30''$. Ignoring instrumental and pointing errors, what should the reading be after 6 repetitions (3DR)?
- $30^{\circ} 16' 30''$
 - $31^{\circ} 16' 30''$
 - $31^{\circ} 39' 00''$
 - $32^{\circ} 05' 00''$
 - $32^{\circ} 16' 30''$
111. Geoid refers to:
- an earth surface averaging the highest and lowest points of a survey.
 - the figure of the earth considered as a sea level surface extended continuously through the continents.
 - an abbreviation for a high precision laser-light EDM.
 - the branch of mathematics concerned with spherical geometry and trigonometry.
 - a small hollow, usually spheroidal, rock with crystals inside.
112. In a traverse, the distances are measured with a precision of 1:12000. What range of uncertainty in angle measurement would most nearly correspond with the precision of the distance measurements?
- 17 seconds
 - 36 seconds
 - 48 seconds
 - 60 seconds
 - 2 minutes
113. In the U.S. Public Land Survey system, the normal number of sections in a township (except in very old surveys) is:
- 4
 - 6
 - 24
 - 36
 - 80

114. A train leaves San Francisco on 9:00 AM PST April 1, 1994 heading for New York at an average of 50 MPH. Another train leaves New York at 5:00 PM EST April 1, 1994 heading for San Francisco at an average of 40 MPH. Assuming it is 3000 track miles between New York and San Francisco, how far from San Francisco will the two trains collide.
- a. 1500 miles
 - b. 1777 miles
 - c. 1333 miles
 - d. 1222 miles
 - e. 1666 miles

115. The notes shown were taken with a direction theodolite. Compute the angle between B and C.

Position No. 3

A	D	90° 00' 02"
	R	269° 59' 58"
B	D	116° 25' 51"
	R	296° 25' 48"
C	D	321° 16' 07"
	R	141° 16' 09"

- a. 152° 16' 13"
 - b. 180° 00' 02"
 - c. 180° 00' 05"
 - d. 204° 50' 16"
 - e. 204° 50' 18.5"
116. Which of the following is not an acceptable form of parol evidence?
- a. Testimony relating to the former position of a monument when written evidence is not clear.
 - b. Testimony correcting statements in the deed.
 - c. Testimony as the general reputation of a monument.
 - d. Testimony of the general meanings of words and customs at the date of the deed.
 - e. Testimony to explain a latent ambiguity.

117. For a 2000-foot long closed traverse, the following have been computed:

Sum of North Latitudes = 515.30'

Sum of East Departures = 845.40'

Sum of South Latitudes = 515.00'

Sum of West Departures = 845.00'

The traverse closure precision is:

- a. 1/6667
 - b. 1/5000
 - c. 1/1720
 - d. 1/2000
 - e. 1/4000
118. The contour line pattern indicates a:
- a. borrow pit
 - b. ridge
 - c. swale
 - d. stream
 - e. saddle



119. Section 18 of T21N, R6W, was subdivided for the first time about 20 years ago. You wish to retrace that survey. For the north line of the NW1/4 of the NW1/4 (also called Lot 1), what measurement should have been used if the official distance for the north line of Section 18, shown in government notes, is 78.39 chains?
- 10.00 chains
 - 18.39 chains
 - 19.20 chains
 - 19.60 chains
 - 38.39 chains
120. The following are given data for a horizontal circular curve:
Delta or I = $23^{\circ} 17' 43''$ Radius = 1,435.22 feet PI station = $178 + 56.87$ feet
What is the PT station, in feet?
- $181 + 04.38$
 - $181 + 17.77$
 - $181 + 31.16$
 - $181 + 57.94$
 - $181 + 44.55$
121. Where, from natural causes, land forms by imperceptible degrees upon the bank of a river or stream, the process and end result are called:
- accretion.
 - reliction.
 - revulsion.
 - littoral.
 - erosion.
122. Possession lines may be used as field evidence to prove the physical location of record title if:
- record title is based on an original survey and possession was established soon after the original survey was made.
 - possession has existed for more than the statutory period.
 - there has been an unwritten agreement between the adjoining parties.
 - the adjoining parties have acquiesced in the possession line.
 - the adjoining parties are estopped from claiming to the true line when found.
123. In 1886 the magnetic bearing of a line was found to be $N 87^{\circ} 55' W$ when the declination was $4^{\circ} 37' W$. If today, the declination is $0^{\circ} 12' E$, what would the magnetic azimuth (from north) of the same line be?
- $92^{\circ} 20'$
 - $267^{\circ} 16'$
 - $267^{\circ} 40'$
 - $276^{\circ} 30'$
 - $276^{\circ} 54'$
124. Given: $10x + 5y = 235$
125. $21x + 9y = 405$
Solve for y:
- 36
 - 6
 - 15
 - 45
 - 59

126. An aircraft carrying an aerial camera of focal length 6 inches flies over an area with average elevation of 3,000 feet above mean sea level (M.S.L.). What should be the height of the aircraft in feet above M.S.L. to obtain photography with an average scale of 1:30,000?
- 12,000
 - 15,000
 - 18,000
 - 21,000
 - 30,000
127. An EDM distance of one mile is measured at an elevation of one mile. The earth's radius, R , is assumed to be 20,906,000 feet. What is the sea level distance in feet?
- 5270.02
 - 5278.67
 - 5280.00
 - 5281.33
 - 5291.99
128. When is it proper to apply proportionate measurement to the location of property corners?
- To distribute a few feet of gap found to exist between a subdivision boundary and the boundary of the original tract.
 - When relocating lost corners in a sequence conveyance.
 - When relocating lost corners in a platted subdivision.
 - All of the above.
 - None of the above.

129. A portion of a deed reads as follows:

"... from an iron pipe at A proceed N 45° E a distance of 500.00 feet to an old truck axle at B; thence proceed N 30° W a distance of 700.00 feet to an iron pin at C".

The iron pins are found and verified as correct but the truck axle is found to be N 45° E 510 feet from point A. What action should the surveyor take?

- Use all of the distance and bearing descriptors because they are controlling.
 - Use all of the distance and bearing descriptors because land surveyors seldom use truck axles for monuments
 - Establish the point B using "N 45° E a distance of 500.00 ft" since this retraces the steps of the original surveyor.
 - Intersect the two distances given because distances usually are controlling over bearings.
 - Use the location of the truck axle as found.
130. Looking at the sketch to the right, if the bearing from A to B is N72° 19' 40" E, the radius of the horizontal curve is 1850.00 feet and the arc length is 807.51 feet, what is the bearing from B to C?
- S 82° 39' 47" E
 - N 82° 39' 47" E
 - N 47° 19' 07" E
 - S 47° 19' 07" E
 - N 92° 20' 13" E

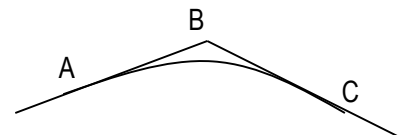

131. The center of a standard section of land is
- The point of intersection of two lines; one run for the NE section corner to the SW section corner, and the other from the NW Sec. corner to the SE Sec. corner.
 - A point located 40 chains south and 40 chains West of the NE section corner
 - A point located 40 chains north and 40 chains east of the SW section corner
 - The point of intersection of a line from the north ¼ corner to the south ¼ corner with a line running from the east ¼ corner to the west ¼ corner
 - A point identified by the intersection of the meridian line and the range line

132. Which Coordinate systems is the best for GIS
- WGS84
 - State Plane Coordinates
 - Universal Transverse Mercator
 - Albers
 - Any system
133. Metadata is
- The database that contains the spatial information
 - The underlying data for all of GIS
 - The portion of the software that maintains meters
 - The data about the data
 - Positional information stored about each object.
134. Raster data is
- Scanned images
 - Pixel based data types
 - CAD files
 - Tabular data
 - Always thematic
135. An Attribute is similar to
- A description attached to a surveyed point.
 - The precision of a surveyed point
 - The layer names in a CAD drawing
 - The blocks used in a CAD drawing
 - The raw data used to compute a surveyed point
136. Topology means
- There are contour lines
 - Properties of an object that do not change, even if the shape changes
 - The direction of a line
 - The relation of an object to the surface of the earth
 - The study of maps
137. The reason Land Surveyors do not regularly use GIS is:
- It is not precise enough
 - It can not hold the information that is collected by a surveyor
 - It can not display the information that is required on a map
 - It was not originally designed as an engineering tool
 - The Land Surveyors Act does not allow GIS to be used for surveys.
138. Using the approximations that the celestial sphere rotates once in approximately 24 hours and Polaris has a declination of approximately $89^{\circ} 10'$ and the bearing to Polaris is approximated by the following equation:
- $$Z = (\sin \epsilon)(\rho) / \cos(\text{Latitude})$$
- The azimuth error resulting from a 1 minute timing error is most nearly:
- 04"
 - 09"
 - 15"
 - 18"
139. Which of the following correctly describes a characteristic both Cartesian coordinates and polar coordinates share?
- Each point has only one unique coordinate pair
 - Coordinates are expressed in ordered pairs
 - Angles are measured clockwise from north in degrees, minutes and seconds
 - Coordinates are always positive

140. As one proceeds northward from the equator, which of the following does NOT happen?
- a. Meridians converge
 - b. Latitudinal lines are parallel
 - c. The force of gravity increases
 - d. The distance represented by a degree of latitude gets shorter

141. For the program flow chart right, the final value of Variable C is:
- a. 8
 - b. 9
 - c. 10
 - d. 11

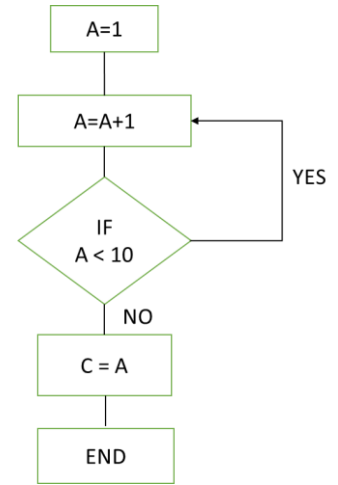

142. Which of the following can be depended upon to define the flow of water?
- a. From a higher ellipsoidal height to a lower ellipsoidal height
 - b. From a higher geodetic height to a lower geodetic height
 - c. From a higher orthometric height to a lower orthometric height
 - d. From a higher dynamic height to a lower dynamic height

143. Until the 1940's the Coast and Geodetic Survey stamped the elevation of a point on its monuments. In what sense would these elevations be obsolete now?
- a. They would be expressed in feet not meters
 - b. The elevations would be based on the Clarke reference ellipsoid
 - c. The elevations would not be in the North American Datum of 1988
 - d. The elevations would be dynamic rather than orthometric.

144. Which of the following formulas correctly represents the basic relationship between geodetic, geoidal and orthometric heights?
- a. $H = h + N$
 - b. $h = H + N$
 - c. $N = H + h$
 - d. None of the above

145. The Grid Azimuth from Point "Monterey" to "KSLY" (4.5 miles away) is $253^{\circ} 15' 48.2''$. The convergence angle is $-1^{\circ} 56' 34.5''$ and the Laplace correction is $+ 4.6''$. What is the geodetic azimuth from "Monterey" to "KSLY"
- a. $251^{\circ} 19' 09.1''$
 - b. $251^{\circ} 19' 13.7''$
 - c. $251^{\circ} 19' 18.3''$
 - d. $255^{\circ} 12' 18.1''$
 - e. $255^{\circ} 12' 22.7''$

146. The grid distance from "Monterey" to "KSLY" is 7,242.062 meters. The Ellipsoidal Reduction factor at Monterey is 0.99995632 and the line scale factor at Monterey is 0.99984532. What would you expect the measured horizontal distance from Monterey to KSLY to be.
- a. 23,755.29 sFt
 - b. 23,752.15 sFt
 - c. 23,764.76 sFt
 - d. 23,764.71 sFt

147. What two factors affect combined distance scale value (Circle both)
- a. Distance
 - b. Elevation
 - c. Longitude
 - d. Azimuth
 - e. Latitude

148. 10,000 meters equal?
- 3048.00 U.S. Survey Ft
 - 3048.01 U.S. Survey ft
 - 32,808.33 U.S. Survey ft
 - 32808.39 U.S. Survey ft.
 - 32808.45 U.S. Survey Ft.
149. The traditional world map, commonly used in Grade school is based on a map projection originally devised by:
- Elliot
 - Lambert
 - Washington
 - Mercator
150. Which of the following is true about the Electromagnetic Spectrum?
- Frequency is directly proportional to wavelength
 - Energy is directly proportional to wavelength
 - Infrared wavelength is longer than red
 - Infrared frequency is higher than red
151. Which expression below is equal to 243.1252326°
- 270.1391473 grads
 - 218.8127093 grads
 - 4.24115 radians
 - $243^\circ 08' 30''$
152. Which of the following statements about two dimensional Cartesian Coordinates is incorrect?
- Universal Transverse Mercator coordinates are Cartesian Coordinates
 - Most Cartesian coordinate systems are designed to place all coordinates in the first quadrant
 - Cartesian coordinates derived from positions on the Earth always include distortions
 - Directions in Cartesian coordinate systems are always reckoned from North
153. What is the spatial resolution of Landsat 7 Bands 1-4?
- 10ft x 10ft
 - 10 m x 10 m
 - 30 ft x 30 ft
 - 30m x 30 m
 - 100ft x 100ft
154. Which of the following is not true?
- The signal for each satellite is independent from other satellites and is generated from its own onboard clocks
 - The clocks in GPS satellites may also be called oscillators or frequency standards
 - Every GPS satellite is launched with very stable atomic clock onboard
 - The clocks in any one satellite area allowed to drift up to one nanosecond from GPS time before they are tweaked by the Control Segment
155. GPS is known as a passive system, what does that mean
- The ranges are measured with signals in the microwave part of the electromagnetic spectrum
 - Only the satellites transmit signals; the user receives them
 - A GPS receiver must be able to gather all the signals it bounces off the satellites
 - The signals from the GPS receiver return to the satellites
156. What is the advantage available using a dual frequency GPS receiver that is not available using a single

frequency GPS receiver?

- a. A single frequency GPS receiver cannot collect enough data to perform single, double or triple difference solutions
- b. A dual frequency receiver affords an opportunity to track the P code but a single frequency receiver does not.
- c. A dual frequency receiver has access to the navigation code, a single frequency does not
- d. Over long baselines, a dual frequency receiver has the facility of modeling and virtually removing the ionospheric bias, whereas a single frequency receiver cannot.

157. Which one of the following is not considered a cause for positioning error with GPS

- a. Time difference measurement
- b. Ephemeris Information
- c. Atmosphere
- d. Multipath
- e. All of the above cause errors.

158. When discussing elevations using GPS, what best describes the height of a point above the geoid?

- a. Ellipsoid height
- b. Orthometric height
- c. Geoid Separation
- d. Differential level
- e. Z

159. Which datum is the GPS System based on?

- a. Lambert Conformal conic
- b. Universal Transverse Mercator
- c. NAD83
- d. WGS84
- e. CORS

160. In GPS the acronym we use to describe the quality of the geometry of the solution is:

- a. POD
- b. POP
- c. DOP
- d. SOP
- e. GOP

161. A Geoid is a . . .

- a. Three dimensional model of the world
- b. Two dimensional model of the world
- c. The shape of the earth
- d. The equal potential surface of the earth at sea level
- e. A surface that fits north America well but not the rest of the world

162. Which of the following errors are not reduced by using DGPS or RTK methods?

- a. Atmospheric errors
- b. Satellite clock bias
- c. Ephemeris bias
- d. Multipath

163. Assume a horizontal positional accuracy for the determination of a point using GPS to be 2 cm, and the vertical positional accuracy to be 3 cm. How many meters would two points have to be apart before I could be assured that the error in slope is less than 1.00%?

- a. Greater than 6.00m
- b. Greater than 3.00m
- c. Greater than 3.02m
- d. Greater than 6.04m

164. Presuming all the numbers right of the decimal are significant, which values below is nearest to the precision of

the following coordinates?

Latitude = $60^{\circ} 14' 15.3278''$

Longitude = $149^{\circ} 54' 11.1457''$

- a. ± 10.0 ft.
- b. ± 1.0 ft.
- c. ± 0.10 ft.
- d. ± 0.01 ft.

165. Your firm is performing an ALTA/ACSM Land Title Survey, and you have been furnished with a new title report and copies of all easements listed as exceptions to the title. Your responsibility toward the information contained in the title report is to:
- a. certify that the legal description contained in the title report is correct
 - b. list on your survey all the easements in the title report
 - c. show on your survey the adjoining property owners listed in Section C of the report
 - d. Plot or otherwise note the effect (or non-effect) of each easement listed in the title report
166. Your client wished to obtain a mortgage for a house. A flood hazard certification is required for mortgage approval. From which of the following sources can Flood Hazard Boundary Maps be obtained?
- a. Federal Insurance Administration
 - b. Army Corps of Engineers
 - c. U.S. Geologic Survey
 - d. National and Geodetic Survey
167. On an ALTA/ACASM survey, you find a building that overlaps the property boundary. For this situation, on the survey map, you show it as:
- a. An adverse possession
 - b. A prescriptive easement
 - c. An encroachment and dimension it
 - d. A license to possess
168. Precision in a measurement is influenced by:
- a. Care used in making a measurement.
 - b. Refinement of instrument construction.
 - c. Least count of the scale.
 - d. Number of times the measurement is repeated.
 - e. All of the above.
169. An error of 1 part in 3876 resulted when a taping temperature correction was not made for the steel tape. By how many degrees Fahrenheit did the temperature differ from standard?
- a. 11
 - b. 20
 - c. 27
 - d. 35
 - e. 40
170. If you have a ratio of error of 1/9000 and your traverse was 18,000 feet long, what was your Error of Closure?
- a. 0.5 feet
 - b. 0.9 feet
 - c. 1 foot
 - d. 1.8 feet
 - e. 2 feet

Answer the following 4 questions based on the information about a closed traverse below.

$$\Sigma_{\text{Distances}} = 5000.00 \quad \Sigma_{\text{Latitudes}} = -0.25 \quad \Sigma_{\text{Departures}} = +0.34$$

Unadjusted course Pt "E" to Pt "F" $177^{\circ} 30' 00''$ 625.25'

171. What is the error of closure for the above traverse?

- a. 0.08
- b. 0.18'
- c. 0.29'
- d. 0.42'
- e. 0.59'

172. What is the approximate ratio of error for the above traverse?

- a. 1/27,000
- b. 1/17,400
- c. 1/11,800
- d. 1/9500
- e. 1/8500

173. Using a compass rule adjustment what is the adjusted distance from "E" to "F"?

- a. 625.19
- b. 625.22
- c. 625.25
- d. 625.28
- e. 625.31

174. Using a compass rule adjustment what is the adjusted azimuth from "E" to "F"?

- a. $177^{\circ} 29' 32''$
- b. $177^{\circ} 29' 46''$
- c. $177^{\circ} 30' 00''$
- d. $177^{\circ} 30' 13''$
- e. $177^{\circ} 30' 28''$

175. What maximum uncertainty in measuring a vertical angle of $5^{\circ} 00' 00''$ will result in a precision of at least 1 :20,000 for the derived horizontal distance when the slope distance is 5000.00 feet? (Neglect curvature and refraction)

- a. $0^{\circ} 00' 10''$
- b. $0^{\circ} 13' 05''$
- c. $0^{\circ} 00' 01''$
- d. $0^{\circ} 04' 03''$
- e. $0^{\circ} 01' 58''$

176. An angle was measured by observers a, b and c. The values reported (in each case the mean of several measurements) were respectively

Observer	Mean	#of Meas.
a)	$63^{\circ} 14' 10.5''$	2
b)	$63^{\circ} 14' 11.0''$	4
c)	$63^{\circ} 14' 12.0''$	3

What is the standard deviation of the group, the mean and the standard error?

- a. +/- 0.62" $63^{\circ} 14' 11.22''$ +/- 0.21"
- b. +/- 0.77" $63^{\circ} 14' 11.17''$ +/- 0.44"
- c. +/- 0.21" $63^{\circ} 14' 11.22''$ +/- 0.62"
- d. +/- 0.44" $63^{\circ} 14' 11.17''$ +/- 0.77"

177. Which of the following statements about systematic errors is true:

- 1.) Systematic errors can be "adjusted out".

- 2.) Systematic errors are cumulative in nature.
- 3.) Instruments that are out of adjustment are not a source of systematic error.
- 4.) Systematic errors may be corrected for.
- 5.) Systematic errors and Random errors are the same
 - a. 1 and 3
 - b. 1 and 5
 - c. 2 and 4
 - d. 2 and 5
 - e. 3 and 5

178. Which of the following statements about random errors is NOT true:

- 1.) All measurements, no matter how carefully made, contain random error.
 - 2.) Random errors may modeled by mathematical functions
 - 3.) Random errors obey the laws of probability.
 - 4.) Random errors may be estimated and accounted for by least squares adjustment techniques.
- a. 1
 - b. 2
 - c. 3 and 4
 - d. None of the above
 - e. All of the above

179. 6 different crews were assigned to measure a portion of a single township line. All the section corners were found along the line and it was determined that the corners were all within $0^{\circ} 00' 05''$ of being on a straight line. Each crew performed a series of measurements for their portion of the line. They all used the same equipment and provided the office the following information;

Crew	Mean Distance	Standard Deviation
1	5280.12'	$\pm 0.05'$
2	5279.58'	$\pm 0.08'$
3	5281.07	$\pm 0.12'$
4	5280.79'	$\pm 0.02'$
5	5282.03	$\pm 0.15'$
6	5279.68	± 0.03

Determine the most probable value for the distance of the township line, and the 2-sigma probability for the distance.

180. For a triangulation survey, 12 measurements were taken between point "A" and Point "B", for clarity only the seconds are listed. They are 52.4", 52.8", 51.6", 51.2", 50.6", 52.7", 49.8", 50.3", 51.8", 50.0", 53.0" and 51.7". The FGCC standards for second order class II triangulation survey requires the standard deviation of the mean to be within 0.8". Determine if this angle meets that requirement.

181. The area of a rectangular field is determined using a 100 foot steel tape that has an accuracy of 0.03' (2-sigma). One side of the field is measured as 2304.56 feet, and the other side is 996.32 feet. Assuming it is a perfect rectangle, determine the most probable value for the area and the values error (2-sigma).

182. You have a project that is covers 1 full section plus you need to go out beyond the section lines 720 feet in all directions. Below are the specs for the job.

Contour interval = 2 feet
Plot scale = 1" = 200'
Focal Length = 6 inches
Elevation at Mean Terrain = 2350 feet AMSL
C factor = 1800

Determine the following

- Flying height above mean sea level
- Dimensions on the Neat Model
- Number of Neat Models
- Number of targets
- Size of Target

Based on the partial Datasheet following, answer the following questions

183. What is the name of the monument?
184. What State Plane Zone is it in?
185. What is its orthometric height, in meters?
186. What is the approximate Ellipsoid height in meters?
187. What is the geoid separation at this point?
188. Would this be an appropriate point for GPS?
189. What road is it closest to?
190. What is the approximate distance to the Lewis and Clark Expedition Monument in Feet

From this point you back sighted "Meriwether Montana Wheat Elev" and measured the following to Control Point "Kipp":

Average Horizontal Angle = $295^{\circ} 15' 55''$ Average Horizontal Distance = 5,281.65 m

191. What is the Grid Azimuth to Kipp (SPC)
192. What is the Grid Distance (U.S. Survey Feet) to Kipp (SPC)

```

TM0855 DESIGNATION - MONUMENT
TM0855 PID - TM0855
TM0855 STATE/COUNTY- MT/GLACIER
TM0855 USGS QUAD - KIPP LAKE (1968)
TM0855
TM0855 *CURRENT SURVEY CONTROL
TM0855
TM0855* NAD 83(1992)- 48 35 56.34675(N) 112 47 49.85708(W) ADJUSTED
TM0855* NAVD 88 - 1275.82 (+/-2cm) 4185.8 (feet) VERTCON
TM0855
TM0855 LAPLACE CORR- -2.91 (seconds) DEFLECO9
TM0855 GEOID HEIGHT- -14.70 (meters) GEOID09
TM0855
TM0855; North East Units Scale Factor Converg.
TM0855;SPC MT - 488,394.256 356,933.996 MT 0.99977853 -2 24 42.9
TM0855;SPC MT - 1,602,343.36 1,171,043.29 iFT 0.99977853 -2 24 42.9
TM0855;UTM 12 - 5,384,437.409 367,500.179 MT 0.99981570 -1 20 53.7
TM0855
TM0855! - Elev Factor x Scale Factor = Combined Factor
TM0855!SPC MT - 0.99980240 x 0.99977853 = 0.99958097
TM0855!UTM 12 - 0.99980240 x 0.99981570 = 0.99961813
TM0855
TM0855: Primary Azimuth Mark Grid Az
TM0855:SPC MT - MONUMENT AZ MK 234 08 16.8
TM0855:UTM 12 - MONUMENT AZ MK 233 04 27.6
TM0855
TM0855|-----|
TM0855| PID Reference Object Distance Geod. Az |
TM0855| | | | dddmmss.s |
TM0855| TM0857 MERIWETHER MONTANA WHEAT ELEV APPROX. 2.9 KM 0725437.5 |
TM0855| CN4880 MONUMENT RM 1 13.848 METERS 21427 |
TM0855| TM0672 MONUMENT AZ MK 2314333.9 |
TM0855| TM0854 LEWIS AND CLARK EXPEDITION MON 92.858 METERS 29315 |
TM0855| CN4881 MONUMENT RM 2 35.454 METERS 30824 |
TM0855|-----|
TM0855 U.S. NATIONAL GRID SPATIAL ADDRESS: 12UUU6750084437(NAD 83)
TM0855 MARKER: DO = NOT SPECIFIED OR SEE DESCRIPTION
TM0855 SETTING: 7 = SET IN TOP OF CONCRETE MONUMENT
TM0855 SATELLITE: THE SITE LOCATION WAS REPORTED AS SUITABLE FOR
TM0855+SATELLITE: SATELLITE OBSERVATIONS - June 21, 2006
TM0855 STATION DESCRIPTION
TM0855
TM0855'DESCRIBED BY COAST AND GEODETIC SURVEY 1963 (JCC)
TM0855'THE STATION IS ABOUT 10-1/2 MILES EAST-NORTHEAST OF BROWNING,
TM0855'0.2 MILE NORTH OF U.S. HIGHWAY 2 AND ON THE HIGHEST
TM0855'POINT OF A SMALL EAST-WEST RIDGE BETWEEN THE HIGHWAY AND
TM0855'THE RAILROAD.
TM0855'
TM0855'TO REACH THE STATION FROM THE U.S. POST OFFICE IN BROWNING,
TM0855'GO SOUTH ON MAIN STREET FOR 0.25 MILE TO U.S. HIGHWAYS 2, 89
TM0855'AND 287. TURN LEFT AND GO SOUTH AND SOUTHEAST ON HIGHWAYS
TM0855'2, 89 AND 287 FOR 3.5 MILES TO A FORK AND THE JUNCTION OF U.S.
TM0855'HIGHWAY 2. TAKE THE LEFT FORK, EAST-NORTHEAST ON U.S. HIGHWAY
TM0855'2 FOR 7.8 MILES TO THE AZIMUTH MARK ON THE RIGHT. CONTINUE
TM0855'AHEAD ON THE HIGHWAY FOR 1.2 MILES TO A SIDE ROAD ON THE
TM0855'LEFT AND SIGN (HISTORICAL MONUMENT 500 YARDS). TURN LEFT AND
TM0855'GO NORTHWEST ON GRAVELED ROAD FOR 0.3 MILE TO THE HIGHEST
TM0855'POINT AND THE STATION.
TM0855'
TM0855'THE STATION MARK IS A STANDARD DISK, STAMPED MONUMENT 1963,
TM0855'SET IN THE TOP OF A 12 INCH SQUARE CONCRETE POST PROJECTING
TM0855'3 INCHES. IT IS 70 FEET SOUTH OF THE CENTERLINE OF A GRAVELED
TM0855'ROAD AND 5.8 FEET WEST OF A WITNESS POST.

```